

Learning from Engineering

Prof Danielle George MBE, CEng, FIET,
FRSA, FCGI

Past President of the Institution of Engineering and
Technology (IET)

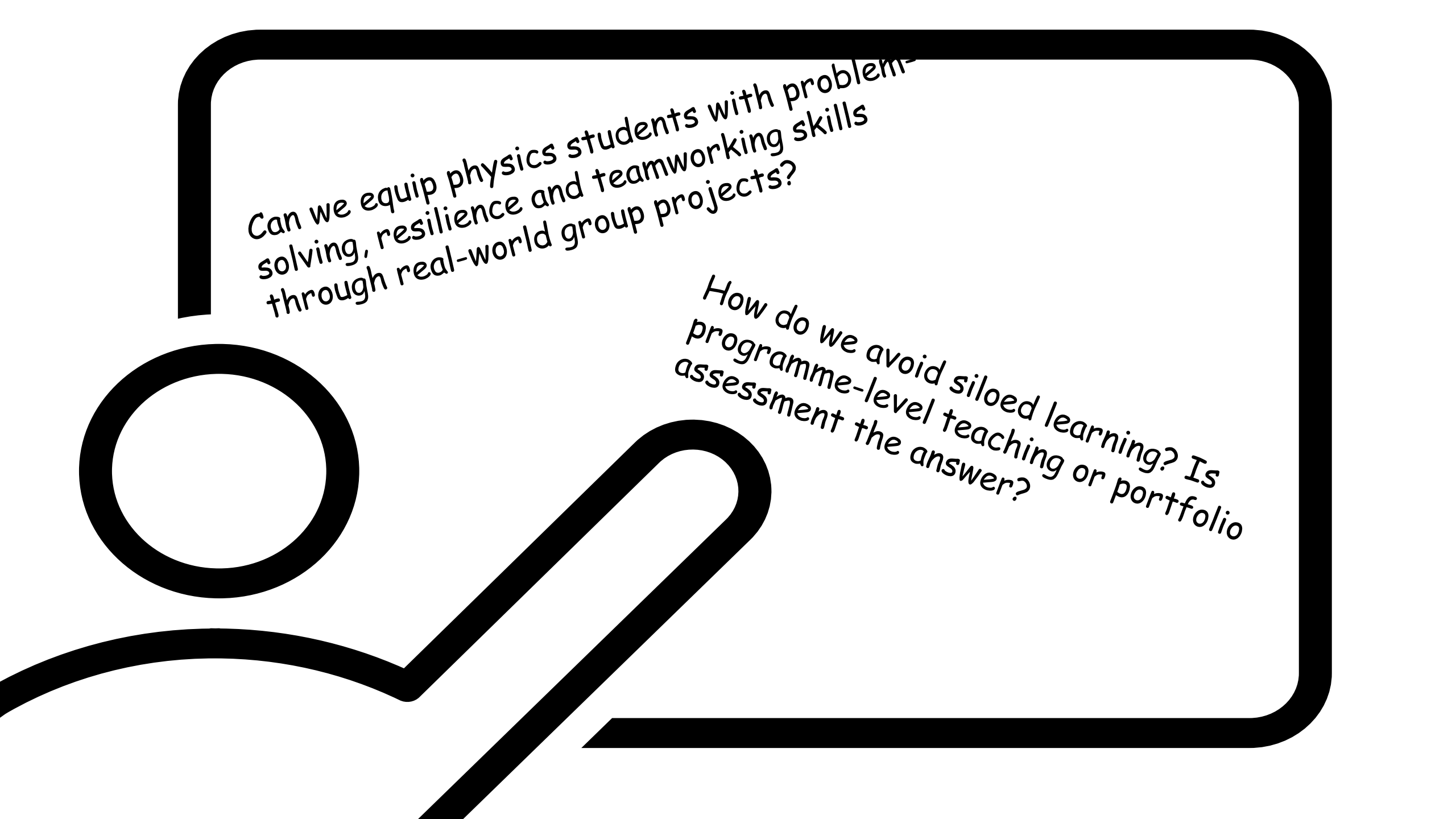

Can we equip physics students with problem-solving, resilience and teamworking skills through real-world group projects?

How do we avoid siloed learning? Is programme-level teaching or portfolio assessment the answer?

WORLD ENGINEERING GRAND CHALLENGES

14 Grand Challenges
for Engineering in the
21st Century



Engineer the tools for Scientific Discovery

Physics + Mathematics = Engineering

Why + How = Engineering

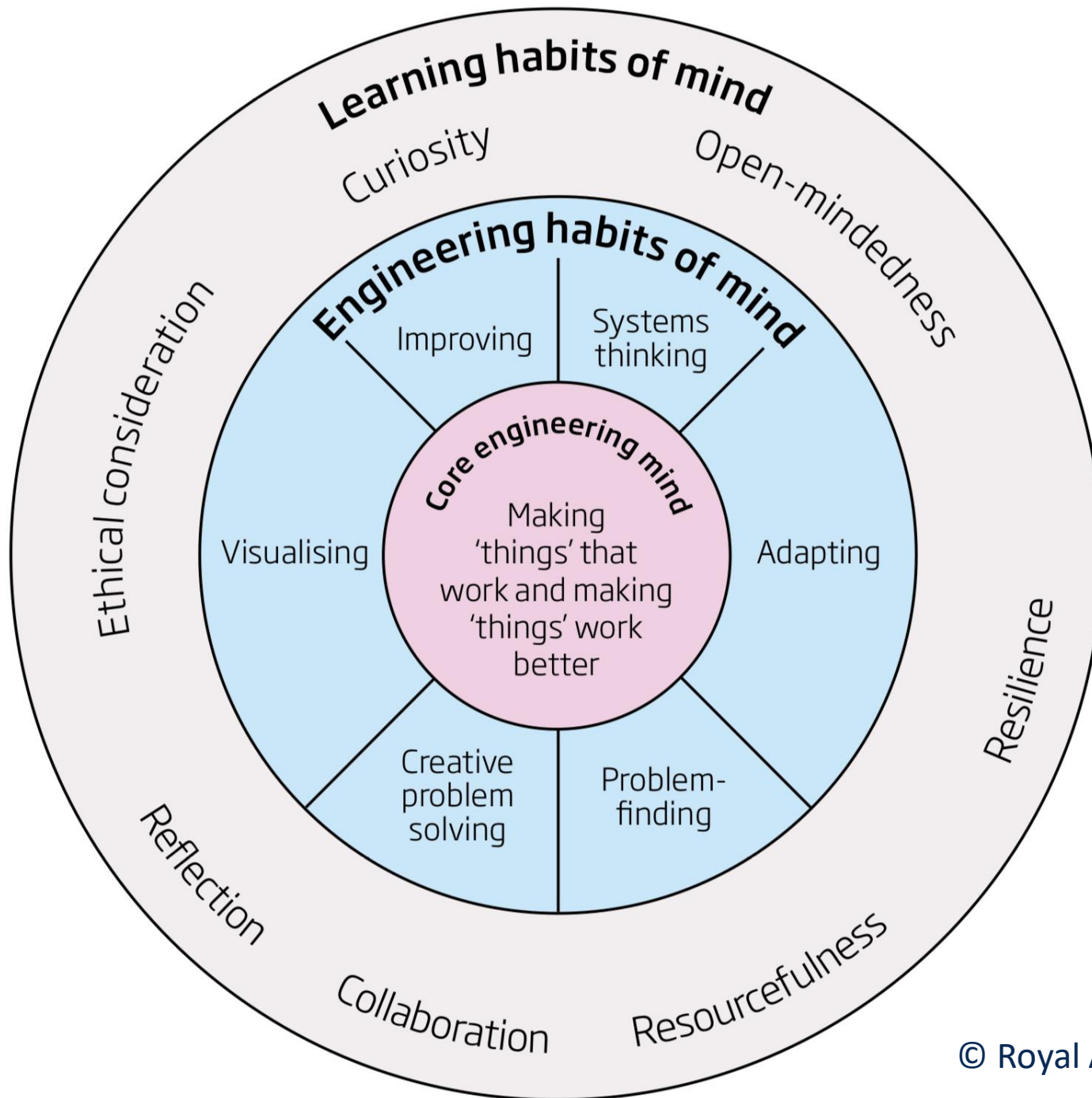

School / UCAS visit day experiment

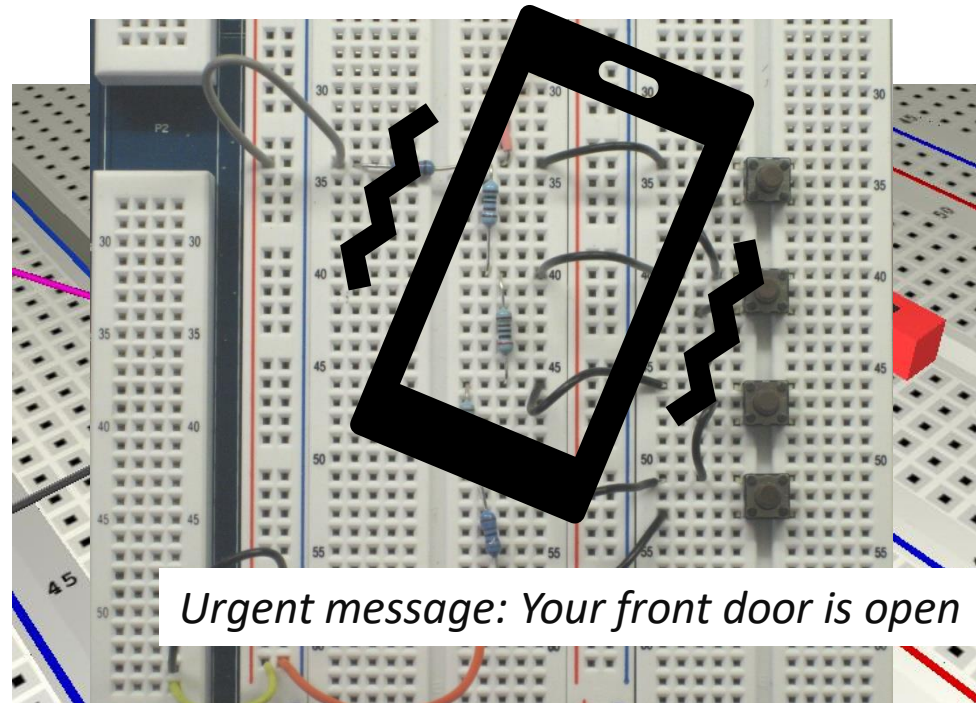

Urgent message: Your front door is open

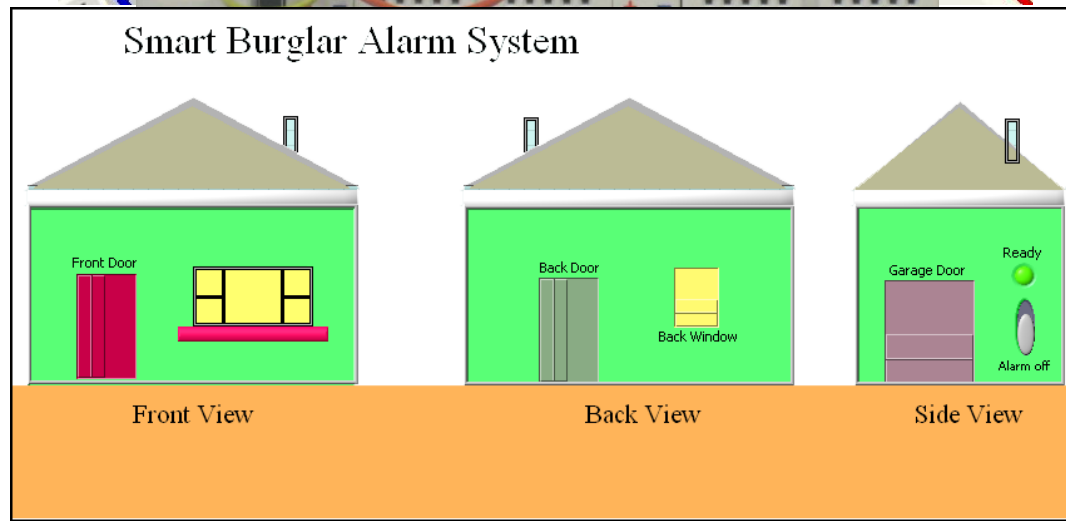

Practical Examination

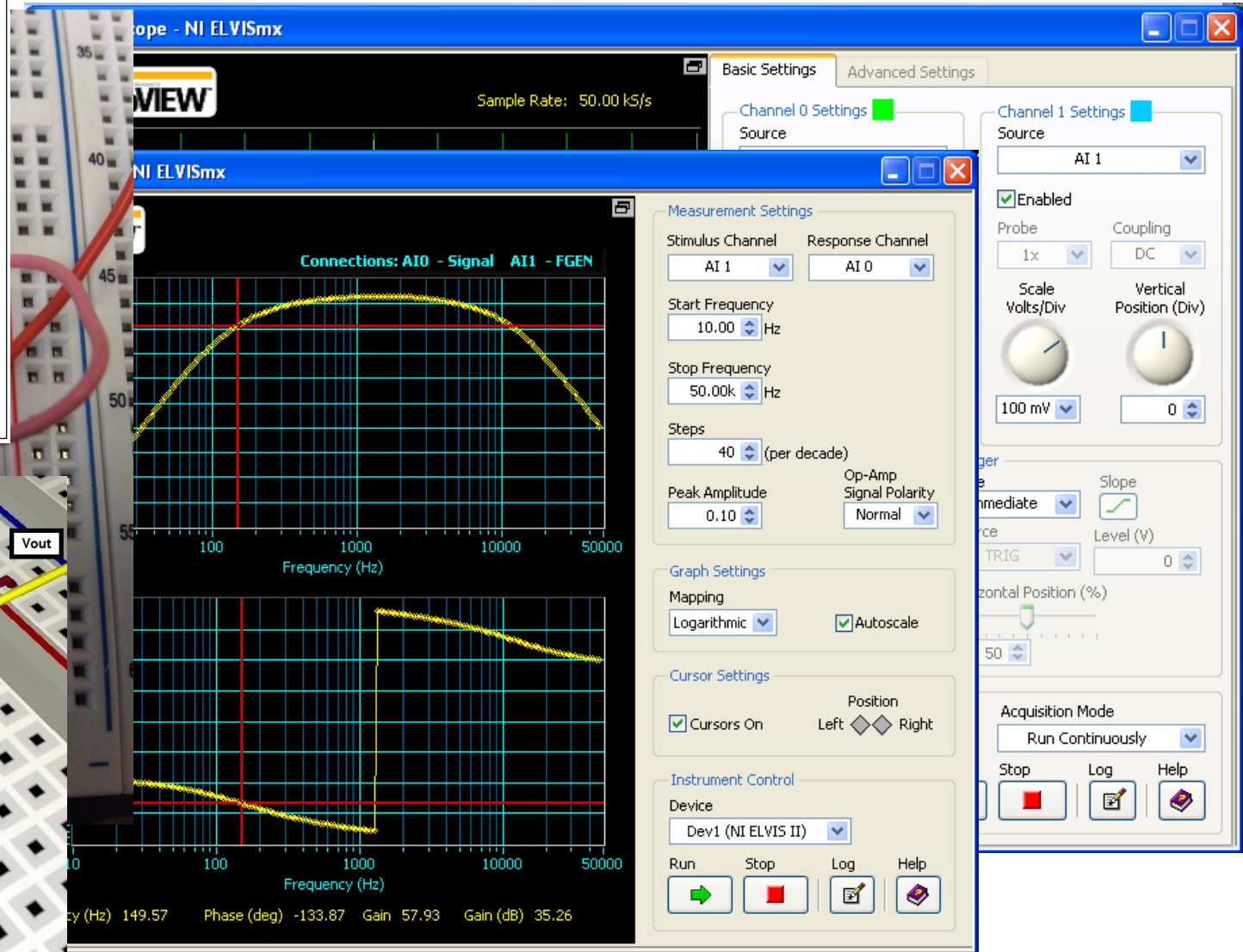
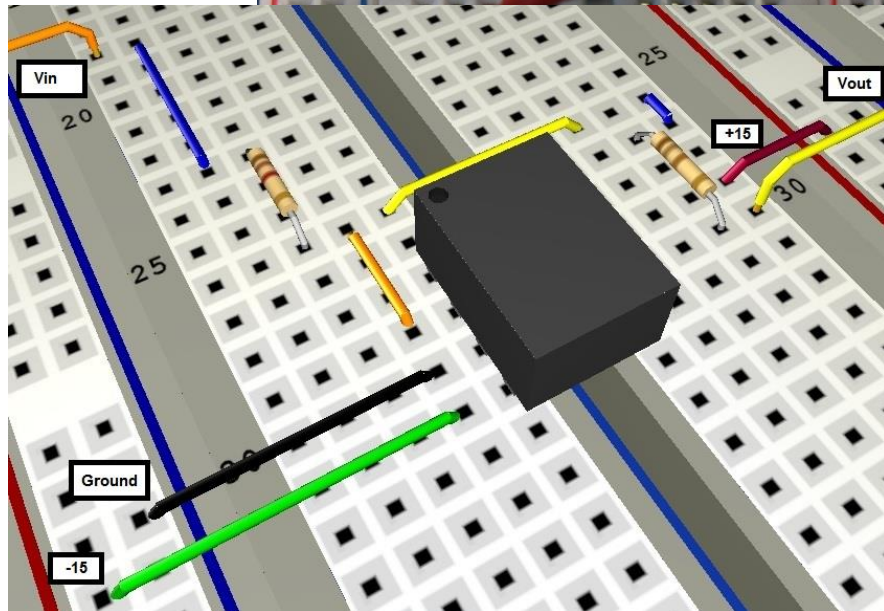
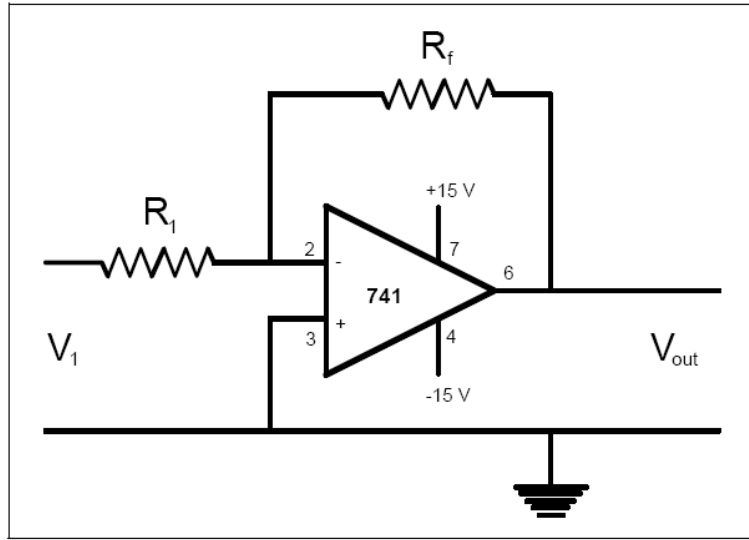

MEng group projects

nationalgrid

SIEMENS
Ingenuity for life



<i>On the successful completion of the course, students will be able to:</i>		<i>Developed</i>	<i>Assessed</i>
ILO 1	Communicate their work through: formal discussion, a website and a promotional video	X	X
ILO 2	Plan and execute group work, appraising the team's performance	X	X
ILO 3	Create a business plan	X	X
ILO 4	Design and implement analogue/digital electronic systems as dependent on the specific project	X	X
ILO 5	Apply project management skills to a team engineering project	X	X



The Scenario

During development, gas turbine engines are instrumented with up to 3000 individual sensors. These sensors are wired to data acquisition systems using up to 12km of cable.

The Challenge

Design a wireless sensor network capable of operating in the space between the engine casing and the nacelle.

The Potential Benefits

- Improved flexibility of sensor deployment
- Reduced deployment time
- Reduced costs

Autonomous Robotic Technology Enabling Minimally Invasive Surgery

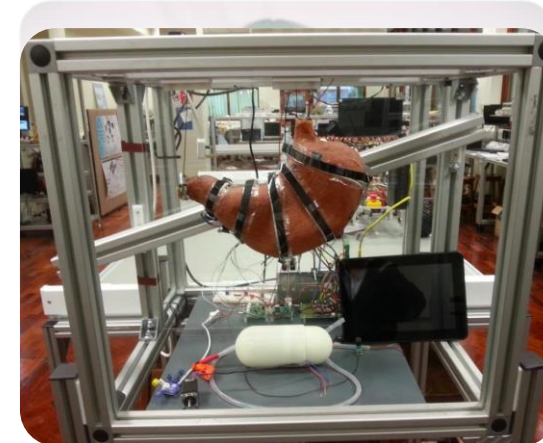
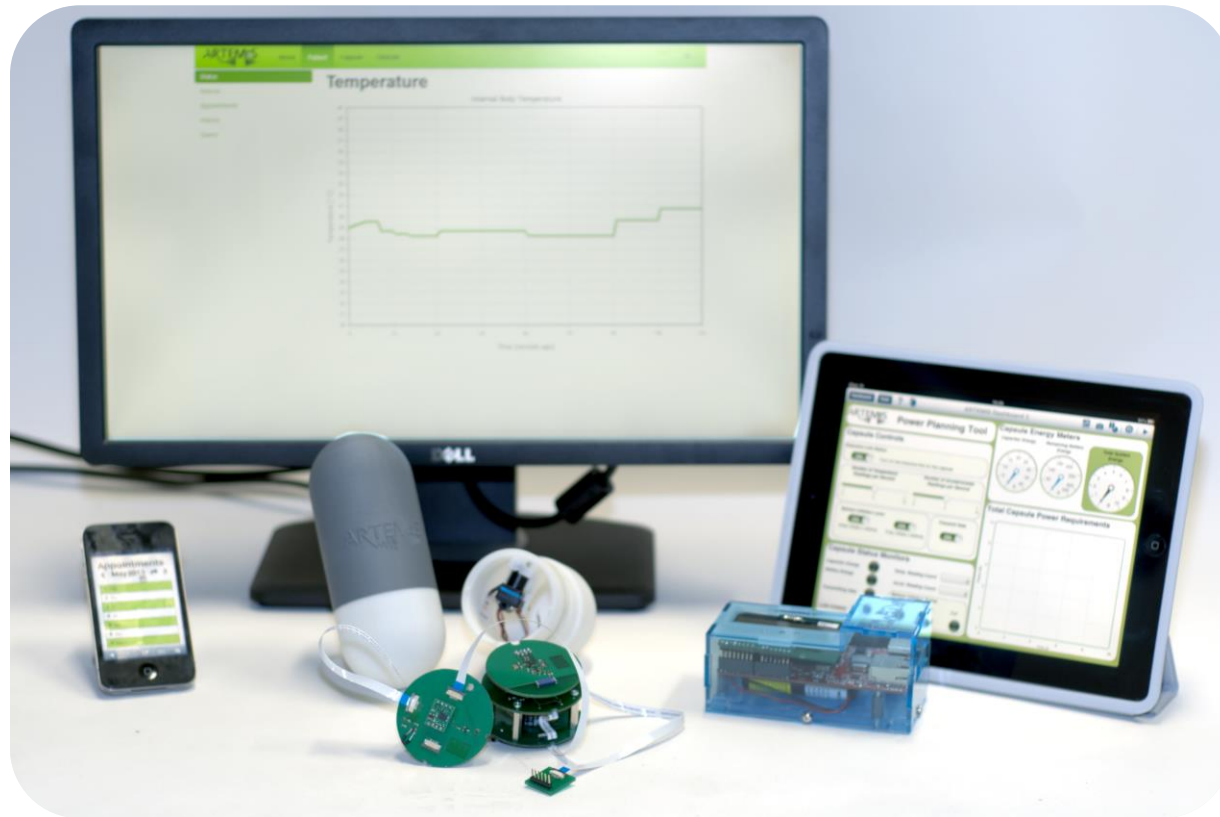
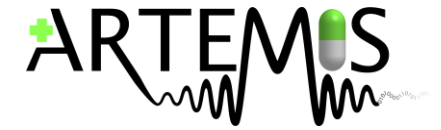

Autonomous Robotic Technology Enabling Minimally Invasive Surgery

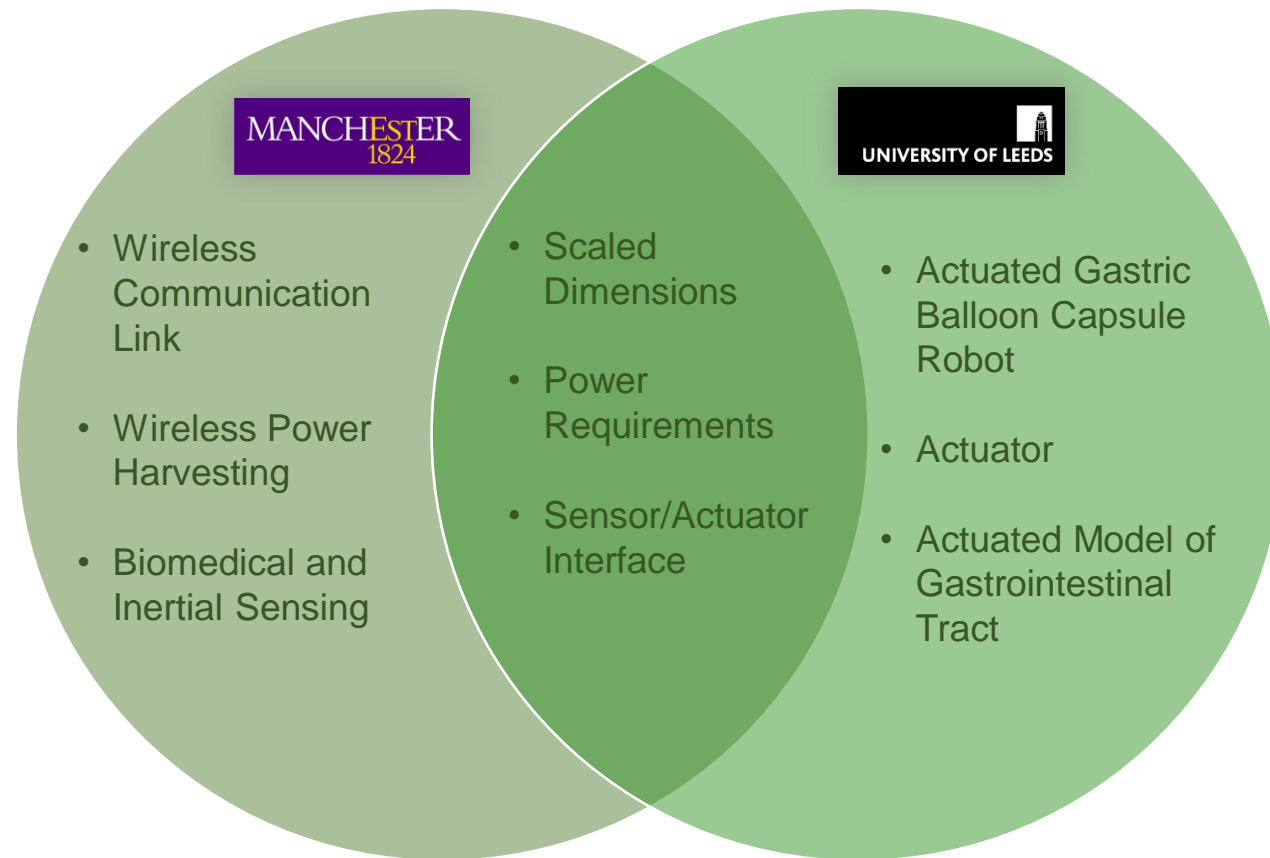
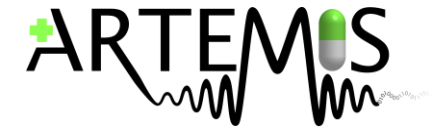

Thinking Differently

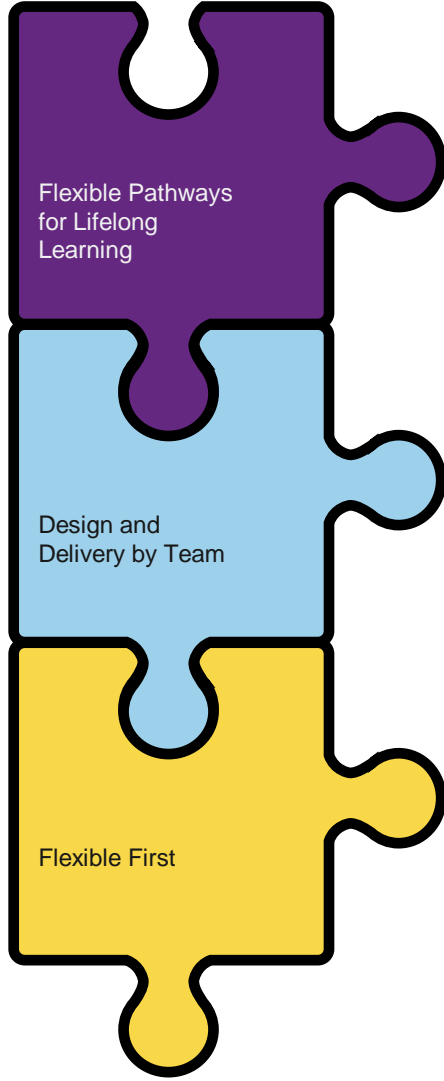

Thinking Differently



Thinking Differently



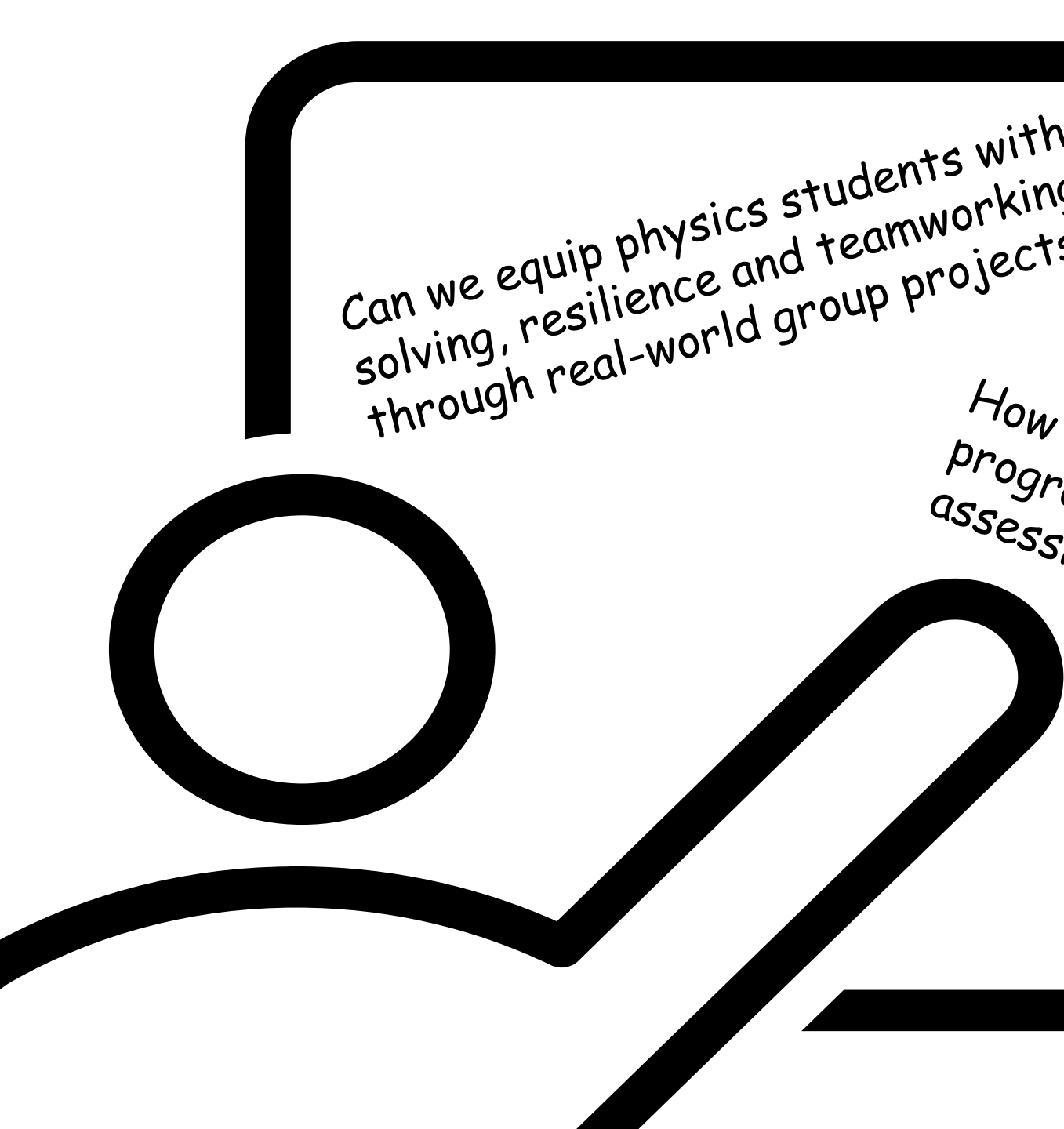

Can we equip physics students with problem-solving, resilience and teamworking skills through real-world group projects?

How do we avoid siloed learning? Is programme-level teaching or portfolio assessment the answer?